

Montageanleitung

8802-B/Bnw bis 8810-B/Bnw (Darstellung: 8802-B)

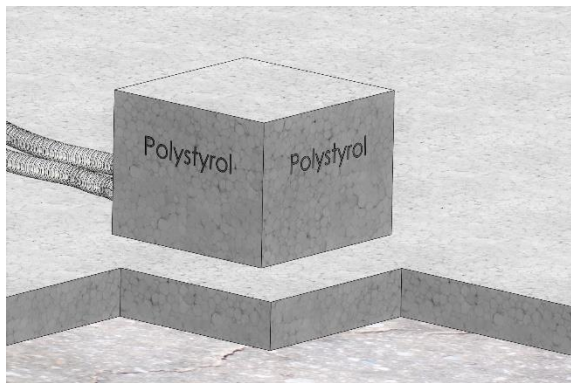

Polystyrolblock jeweils ca. 40mm größer in Länge, Breite und Höhe als Dose

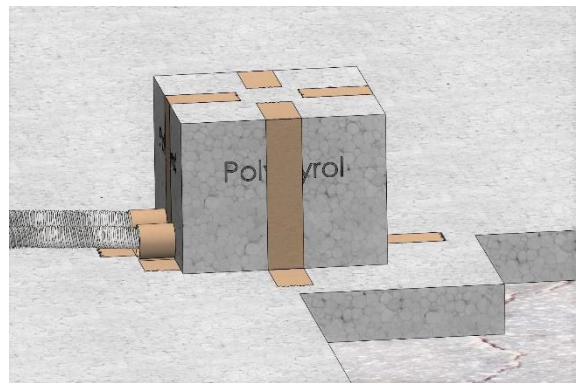

Polystyrolblock für 8802-B (Beispiel):
Ca. 165mm x 165mm x 110mm

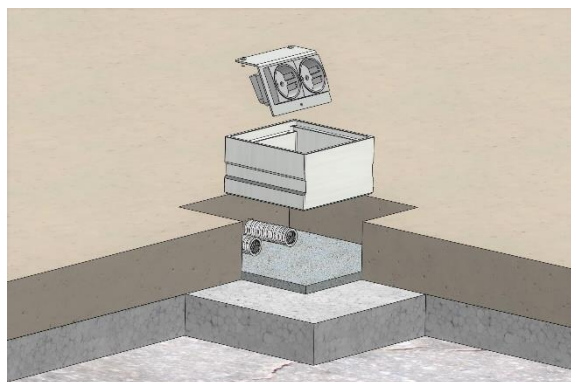
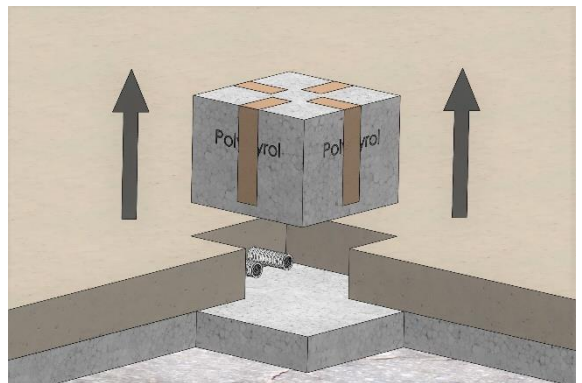
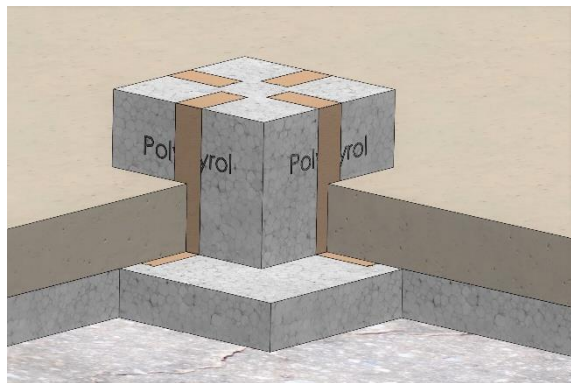

Geräteträger aus Dose herausschrauben
Die Dose in den aufgestrichenen Mörtel setzen

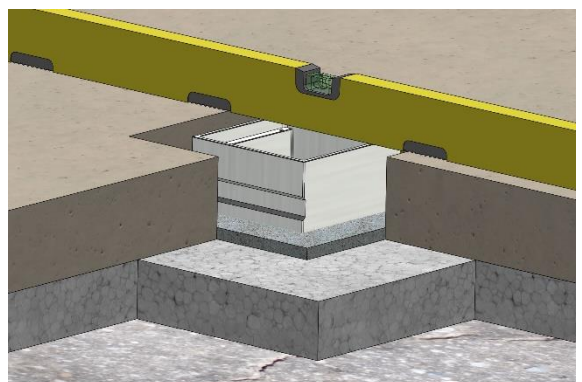

Montageanleitung

8802-B/Bnw bis 8810-B/Bnw (Darstellung: 8802-B)

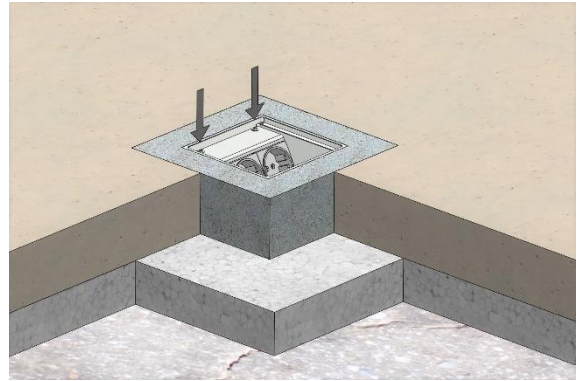
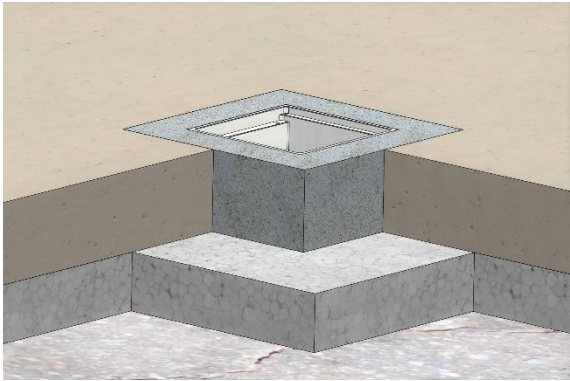

Kabel anschließen
Geräteträger festschrauben

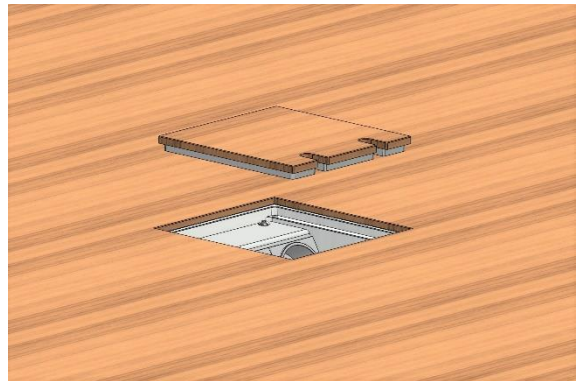
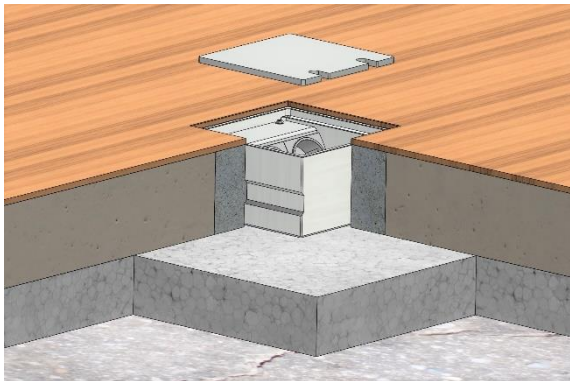

Deckel mit Belag belegen

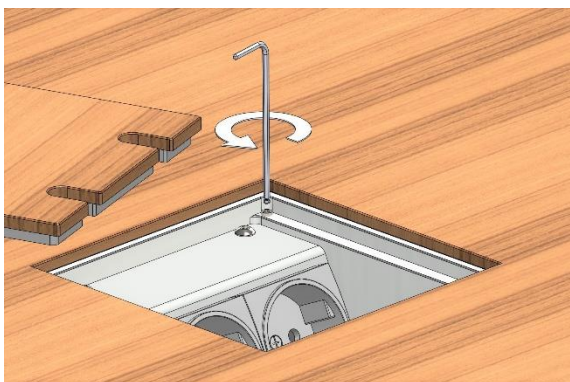

Deckel kann nach oben feinjustiert werden

