

Assembly Instructions

8802-B/Bnw till 8810-B/Bnw (Example shows: 8802-B)

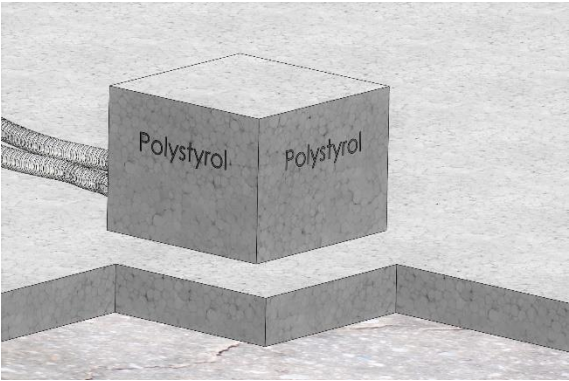

Polystyrene block each about 40mm larger in length, width and height as adapter box.

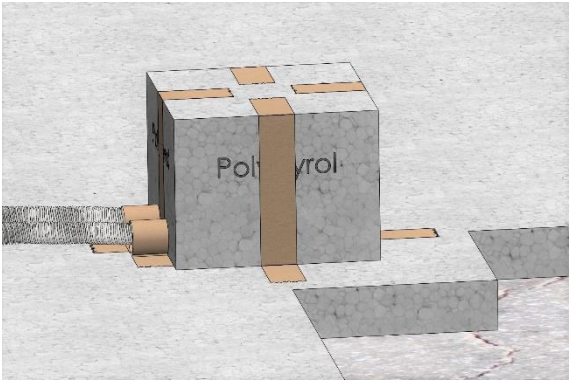

Polystyrene block for 8802-B (Example):
app. 165mm x 165mm x 110mm

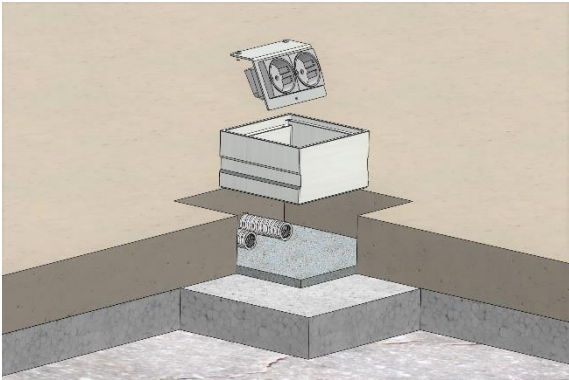
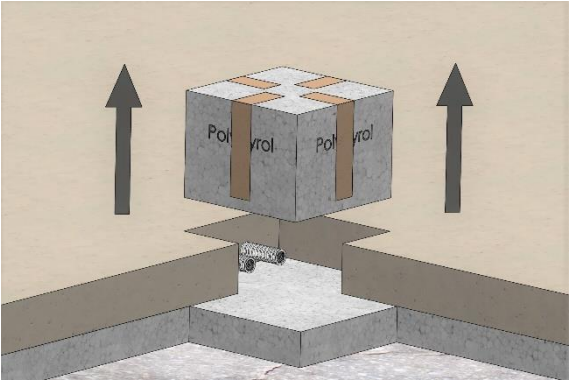
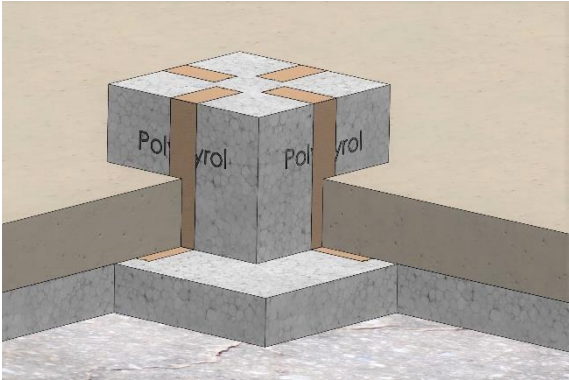

Remove the gear tray and set the box it into the mortar.

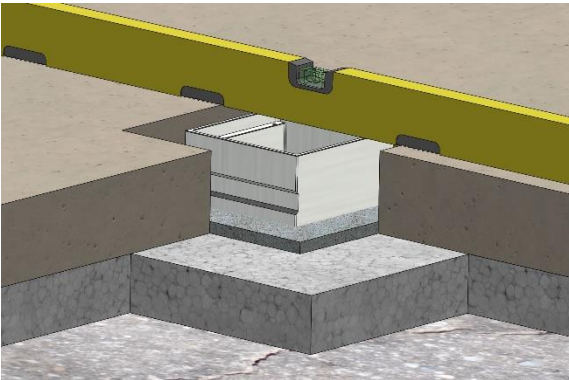

Assembly Instructions

8802-B/Bnw till **8810-B/Bnw** (Example shows: 8802-B)

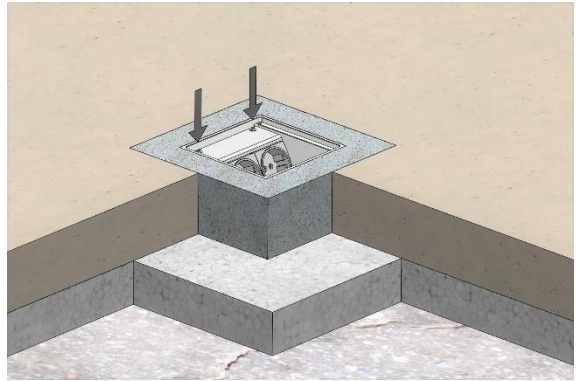
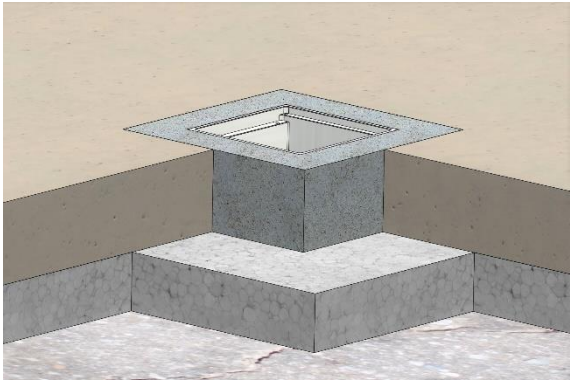

Connect the cables and fix the gear tray.

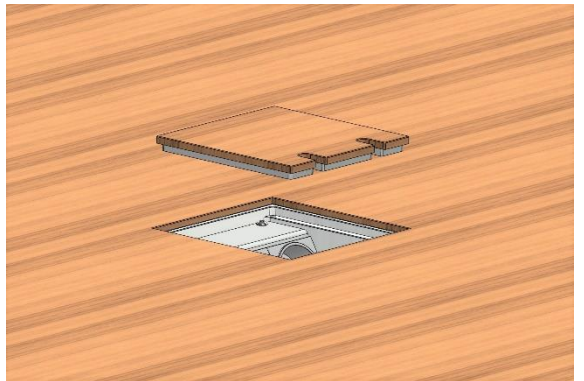
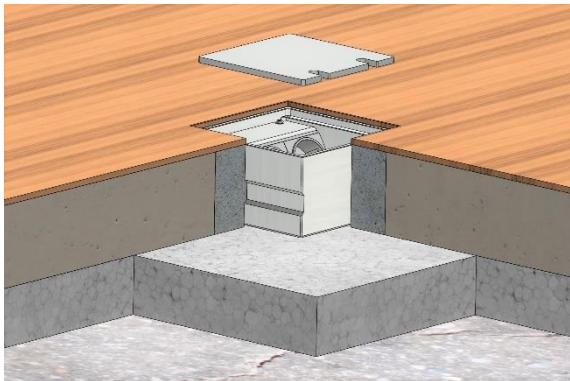

Fix (glue) the covering on the lid.

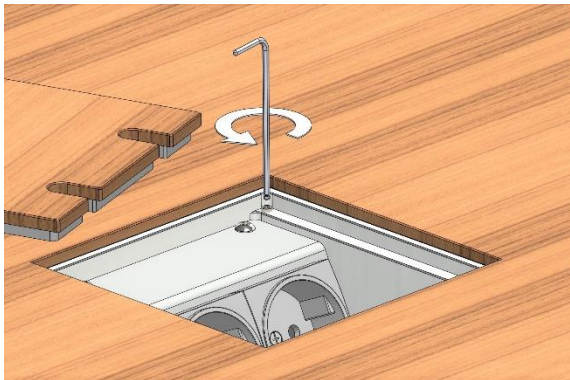

Lid can be fine-adjusted upwards.

